



## ***Faster | Easier | More Reliable | More Consistent | More Durable | More Easily Serviceable***

On the following pages you will find drawings and specs for our Plug-N-Play (PnP™) Integrated Compartment Lighting System (ICLS). In the process of reviewing this system keep in mind the following significant cost savings the fleet owner and its upfitters will realize in standardizing on a thinLUX™ ICLS:

- **Integrated Wiring Harnesses:** Our PnP™ modular harnesses not only make installation faster and easier, they also ensure uniform installation across the spectrum of upfitters greatly increasing reliability and durability making service and maintenance by the fleet owner faster and easier.
- **LED Color & Efficacy:** thinLUX™ uses the latest and most efficient LEDs that provide the most light with the least amount of draw on your batteries and generators. And our LED's Sunlight White color is easy on the eyes.
- **Q-Latch Connectors:** The integration of small latching connectors into the lights & wiring harnesses makes the entire installation not only easier, more reliable, and more durable, but also makes troubleshooting, repair, and replacement faster and less costly.
- **Quick-Release PSA Liner:** The addition of a small tab to the light's BluBond™ PSA liner may appear to be a seemingly insignificant detail but it saves a lot of labor during installation.
- **Repositionable PSA:** Our BluBond™ PSA can be repositioned within the 1<sup>st</sup> 12 hrs following installation reducing upfitters' cost to make corrections & adjustments.
- **Cleanly Removable PSA:** After 24hrs our BluBond™ PSA's urethane properties permit the clean removal of a light for service & replacement. As the PSA is stretched it cleanly releases from the mounting surface.

## Plug-N-Play (PnP™) Compartment Lighting System TL0 Series 12" & 24" Lights with Modular Interconnecting Wire Harnesses

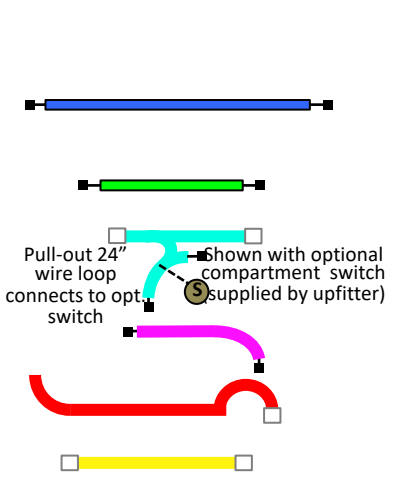
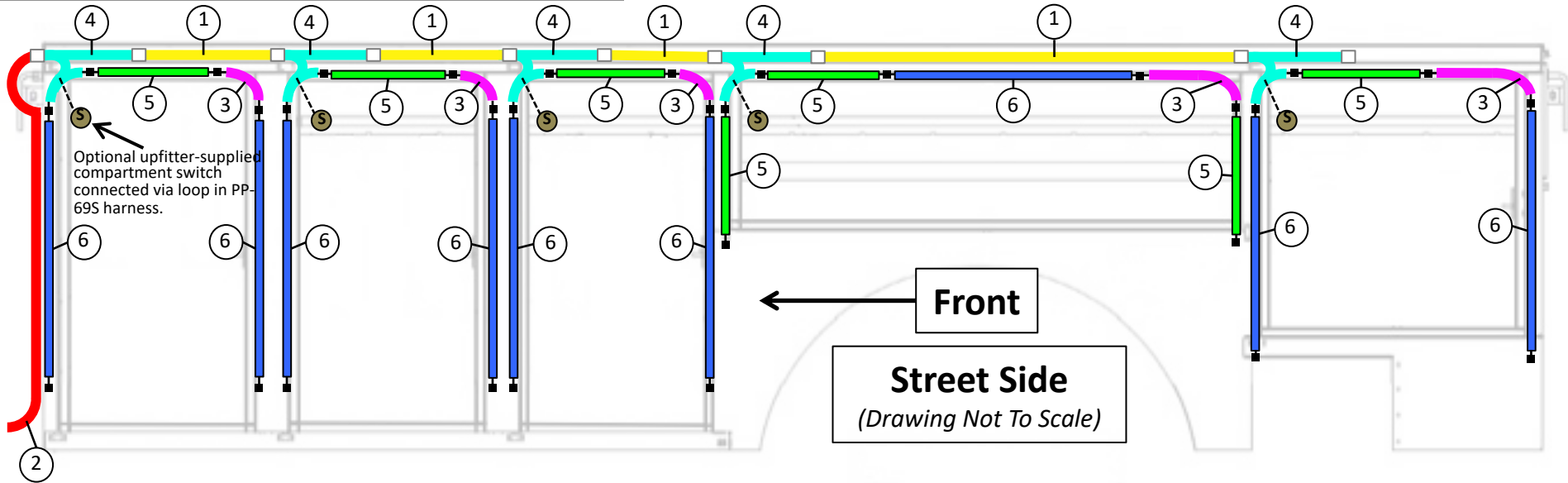

ITEM	PART NO.	DESCRIPTION
6	TL0-24W-PP	ThinLUX™ TL0 LIGHT, 24", WHITE, BluBond™ TAPE MOUNT, 2" PIGTAILS w/M-F Q-LATCH CONNECTORS
5	TL0-12W-PP	ThinLUX™ TL0 LIGHT, 12", WHITE, BluBond™ TAPE MOUNT, 2" PIGTAILS w/M-F Q-LATCH CONNECTORS
4	PP-69S	40W TRUNK LINE DROP CABLE, w/SWITCH WIRE LOOP. JUMPS FROM PP-50 42" TRUNK CABLE EXTENSION TO TL0 LIGHT AND/OR 12" PP-27 JUMPER CABLE.
3	PP-27	40W LIGHT CABLE, JUMPER, 12", M-F Q-LATCH CONNECTORS
2	PP-77	130W TRUNK CABLE, POWER, 60", INTEGRAL FUSE
1	PP-50	130W TRUNK CABLE, 42" EXTENSION, M-F MOLEX CONNECTORS

## Plug-N-Play (PnP™) Compartment Lighting System SL1 Series 12" & 24" Lights with Modular Interconnecting Wire Harnesses

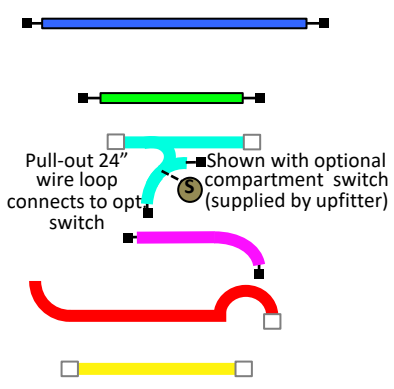
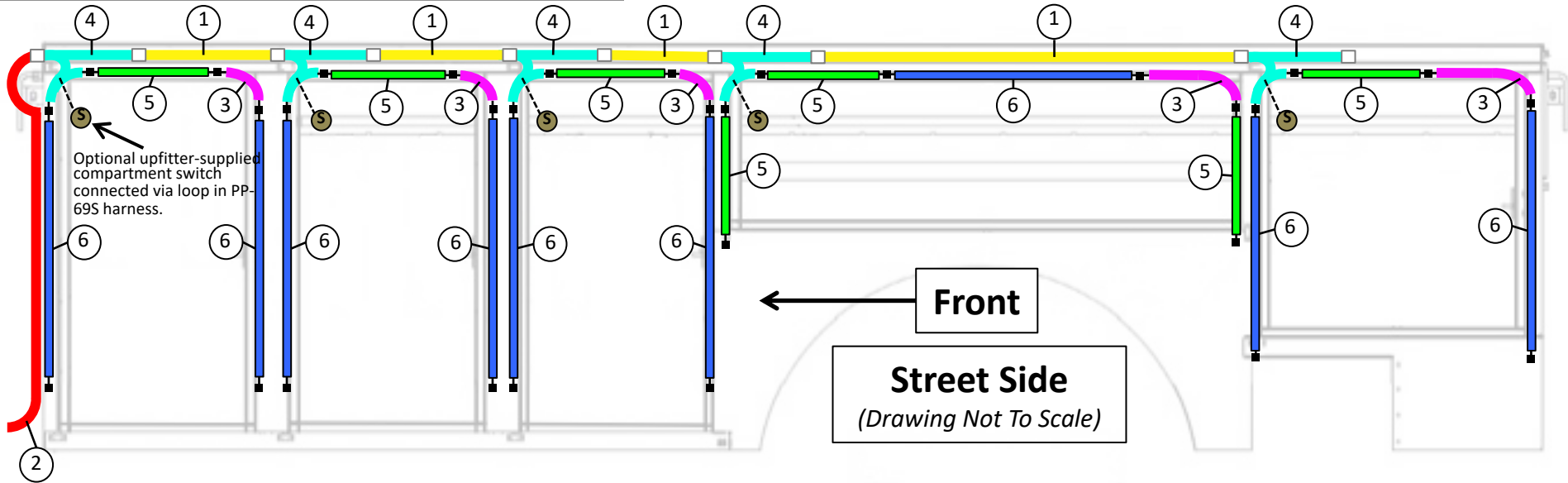

ITEM	PART NO.	DESCRIPTION
6	SL1-24W-PP	ThinLUX™ SL1 LIGHT, 24", WHITE, BluBond™ TAPE MOUNT, 2" PIGTAILS w/M-F Q-LATCH CONNECTORS
5	SL1-12W-PP	ThinLUX™ SL1 LIGHT, 12", WHITE, BluBond™ TAPE MOUNT, 2" PIGTAILS w/M-F Q-LATCH CONNECTORS
4	PP-69S	40W TRUNK LINE DROP CABLE w/SWITCH WIRE LOOP. JUMPS FROM PP-50 42" TRUNK CABLE EXTENSION TO SL1 LIGHT AND/OR 12" PP-27 JUMPER CABLE.
3	PP-27	40W LIGHT CABLE, JUMPER, 12", M-F Q-LATCH CONNECTORS
2	PP-77	130W TRUNK CABLE, POWER, 60", INTEGRAL FUSE
1	PP-50	130W TRUNK CABLE, 42" EXTENSION, M-F MOLEX CONNECTORS

# TLO-xxW-PP

## Plug-N-Play (PnP™) Compartment System Light

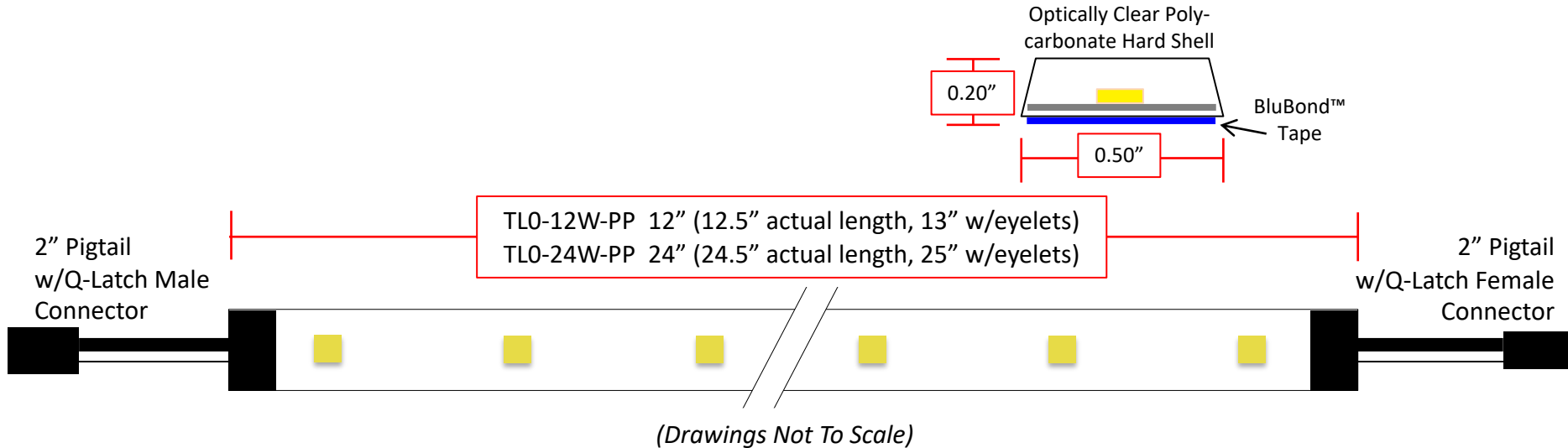

**TLO Std. Lgths:** 12" & 24" \*

**Mounting:** BluBond™ Automotive-grade Urethane Pressure-Sensitive Adhesive Foam Tape for Smooth Surfaces (TL-PSS2). \*\*

**Lumens:** 150 per foot (half bright class)

**Color:** 5700K

**Volts:** 12

**Watts:** 1.5 per foot

**Amps:** .125 per foot

**Pigtails:** 22-gauge

**Waterproof:** IP65 Class

**Warranty:** 5-Year

**Notes:** \* Sizes up to 96" available via special order. Set-up charges apply. Inquire for pricing.

\*\* TL-PSR2 can be specified for mounting TLO lights to rough surfaces such as fiberglass.

# SL1-xxW-PP

## Plug-N-Play (PnP™) Compartment System Light

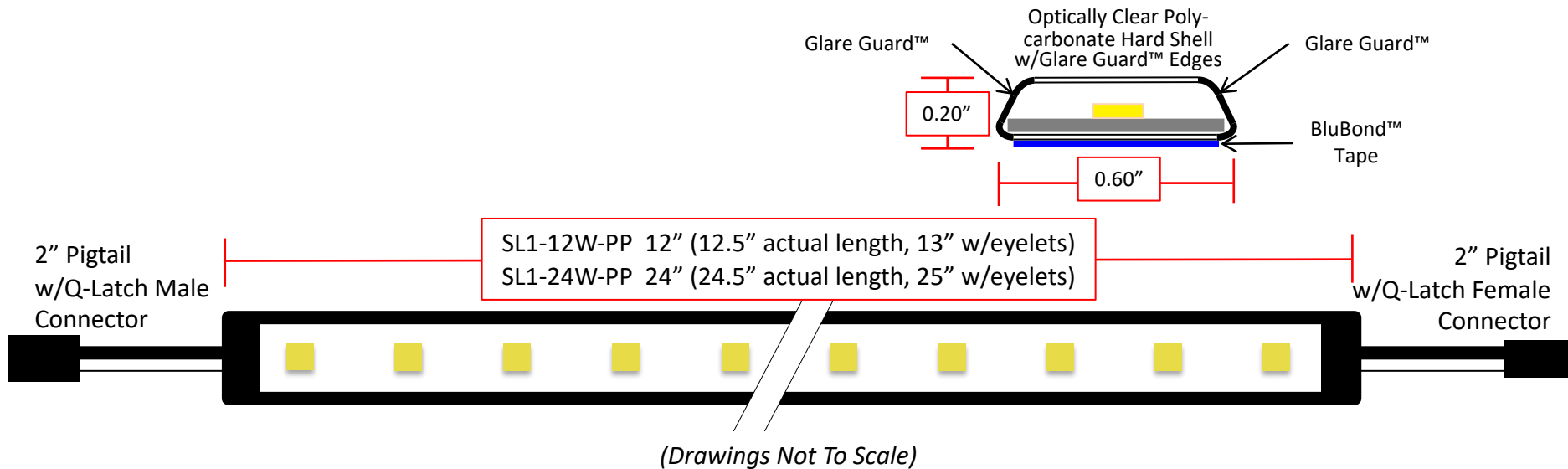

**SL1 Std. Lengths:** 12" & 24" \*

**Mounting:** BluBond™ Automotive-grade Urethane Pressure-Sensitive Adhesive Foam Tape for Smooth Surfaces (SL-PSS2). \*\*

**Lumens:** 300 per foot (single bright class)

**Color:** 5700K

**Volts:** 12

**Watts:** 3.0 per foot

**Amps:** .25 per foot

**Pigtails:** 22-gauge

**Waterproof:** IP65 Class

**Warranty:** Lifetime

**Notes:** \* Sizes up to 96" available via special order. Set-up charges apply. Inquire for pricing.

\*\* SL-PSR2 can be specified for mounting SL1 lights to rough surfaces such as fiberglass.

# PP-77 Trunk Cable - Power

## Plug-N-Play (PnP™) Compartment System Harness

Marine Grade Fuse Holder  
Includes Replaceable 7.5A Fuse

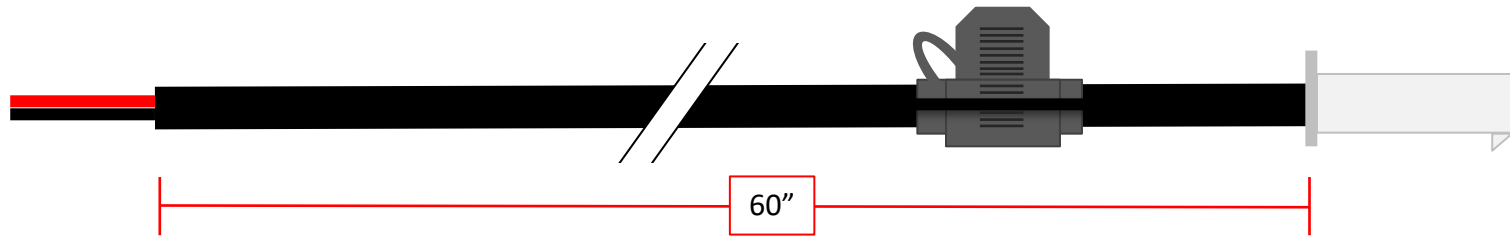

(Drawing Not To Scale)

**Connector:** Molex Plug

**Fuse:** ATC 7.5 amp (default)

**Wire:** 16ga UL1007

**Sleeve:**

High-Density Triple-Weave Polyethylene

High Abrasion Resistance

Fused Ends (will not fray)

Temp Range: -94°F to 257°F

Safety: UL94V

# PP-50 Trunk Cable, 42" Extension

## *Plug-N-Play (PnP™) Compartment System Harness*

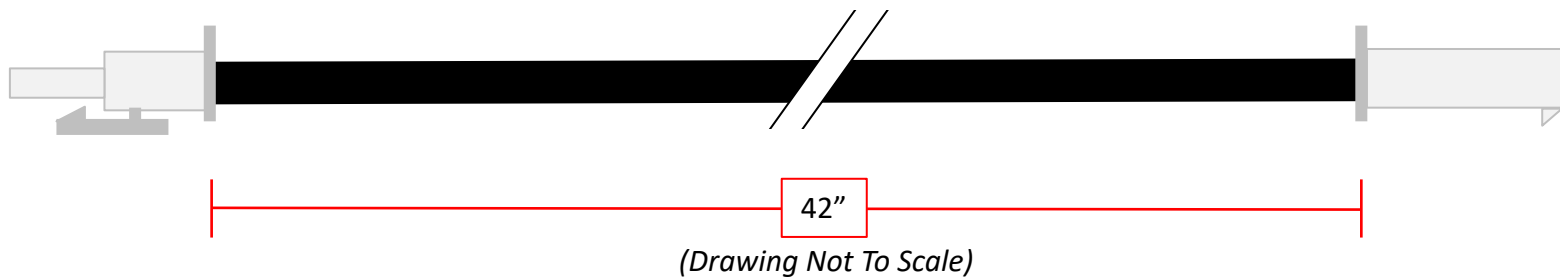

**Connectors:** Molex Plug/Receptacle

**Wire:** 16ga UL1007

**Sleeve:**

High-Density Triple-Weave Polyethylene

High Abrasion Resistance

Fused Ends (will not fray)

Temp Range: -94°F to 257°F

Safety: UL94V



# PP-69 Trunk Cable, Drop

## Plug-N-Play (PnP™) Compartment System Harness

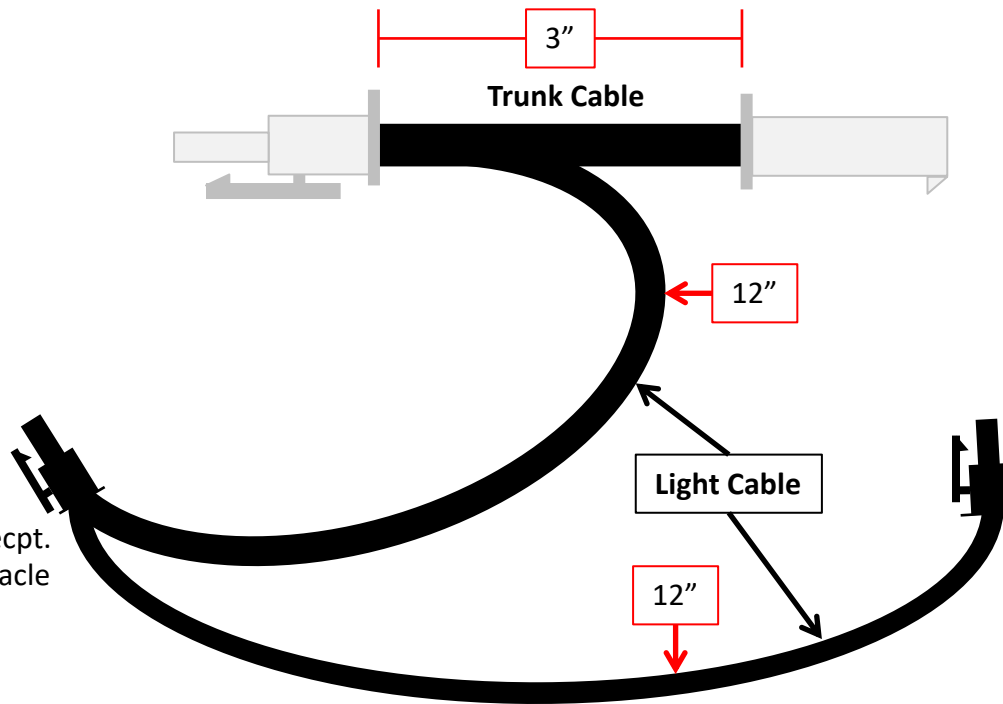

(Drawing Not To Scale)

### Connectors:

**Trunk Cable:** Molex Plug/Recpt.

**Light Cable:** Q-Latch Receptacle

### Wire:

**Trunk Cable:** 16ga UL1007

**Light Cable:** 22ga UL1007

### Sleeves:

High-Density Triple-Weave Polyethylene

High Abrasion Resistance

Fused Ends (will not fray)

Temp Range: -94°F to 257°F

Safety: UL94V



# PP-69S Trunk Cable, Drop w/Switch Wire Loop

## Plug-N-Play (PnP™) Compartment System Harness

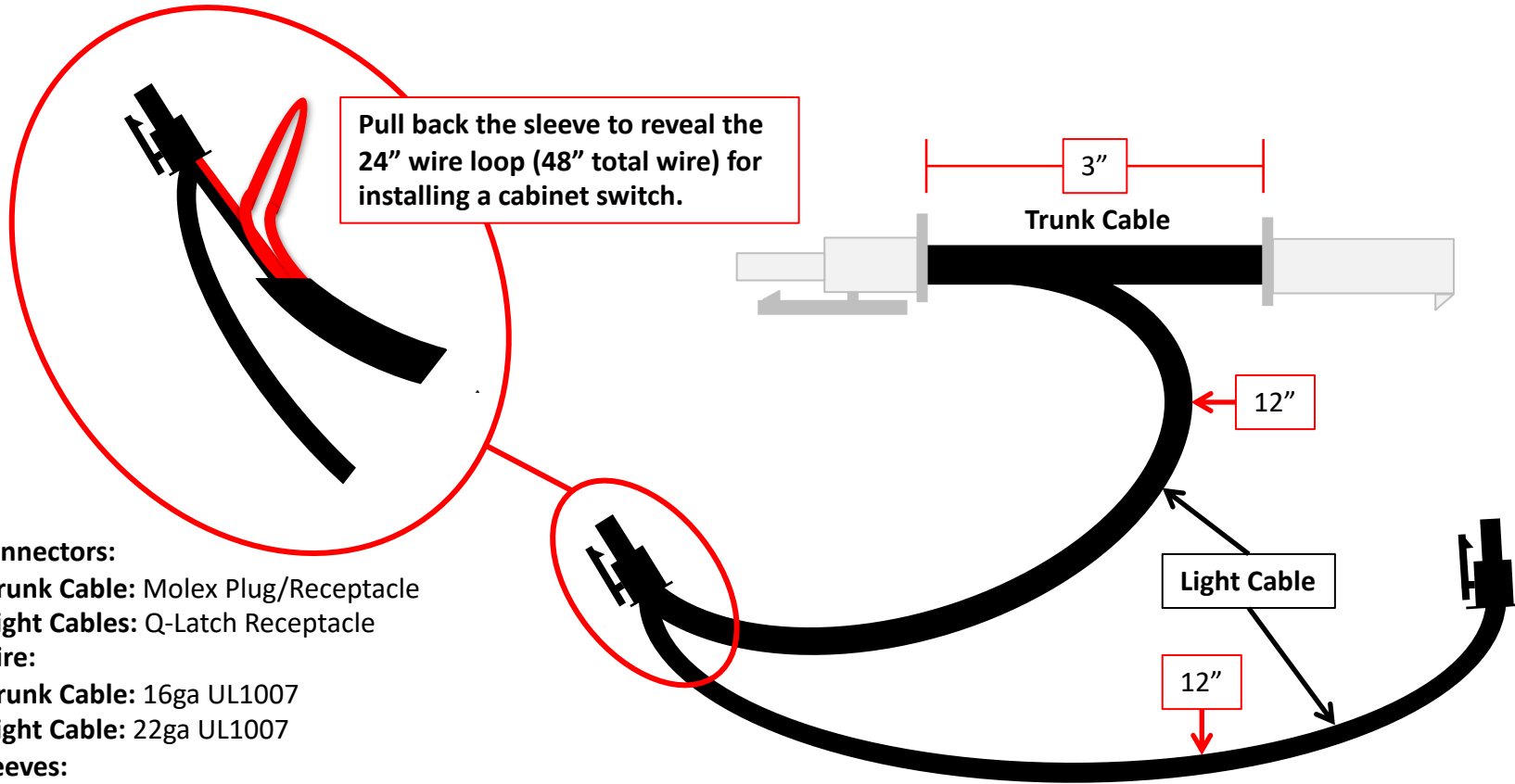

### Connectors:

**Trunk Cable:** Molex Plug/Receptacle

**Light Cables:** Q-Latch Receptacle

### Wire:

**Trunk Cable:** 16ga UL1007

**Light Cable:** 22ga UL1007

### Sleeves:

High-Density Triple-Weave Polyethylene

High Abrasion Resistance

Fused Ends (will not fray)

Temp Range: -94°F to 257°F

Safety: UL94V

(Drawing Not To Scale)

# PP-27 Light Cable, 12" Extension

## Plug-N-Play (PnP™) Compartment System Harness

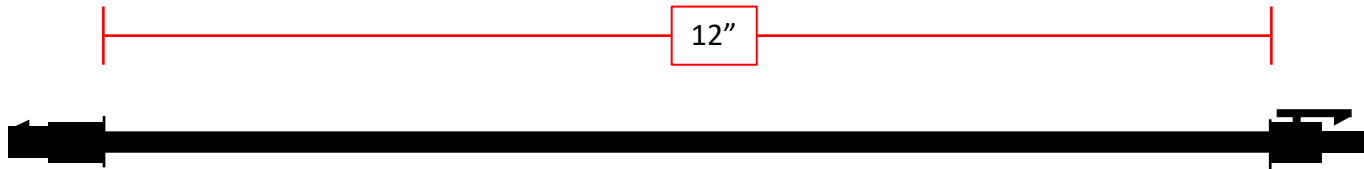

*(Drawing Not To Scale)*

**Connectors:** Q-Latch Plug/Receptacle

**Wire:** 22ga UL1007

**Sleeve:**

High-Density Triple-Weave Polyethylene

High Abrasion Resistance

Fused Ends (will not fray)

Temp Range: -94°F to 257°F

Safety: UL94V